

REVISIONS				
ZONE	REV	DESCRIPTION	DATE	APPROVED

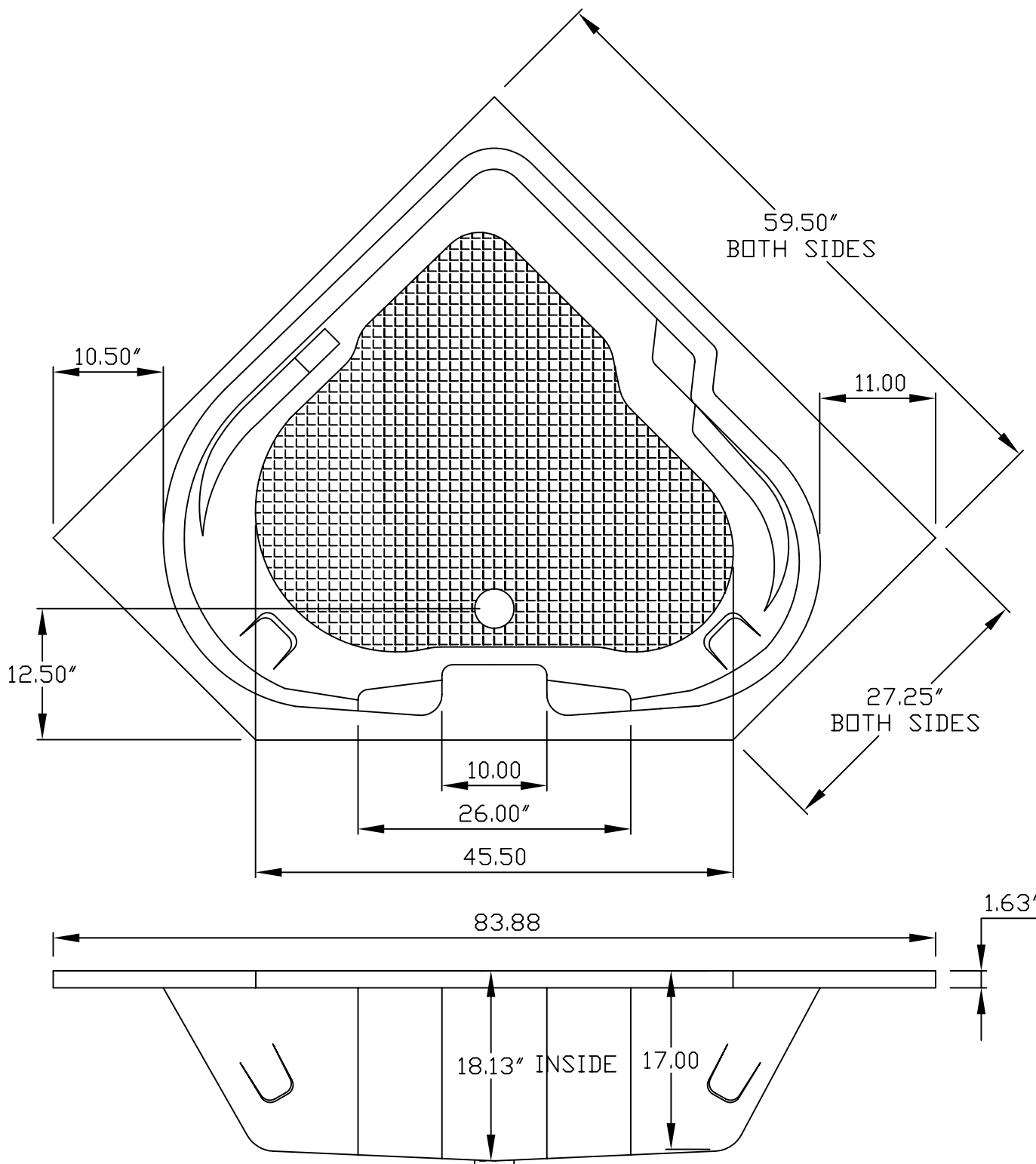

Quality Acrylic Baths

SIZE A	FSCM NO.	DWG NO. QAB MODEL 510	REV IR
SCALE		SHEET 1 OF 1	