

REVISIONS				
ZONE	REV	DESCRIPTION	DATE	APPROVED

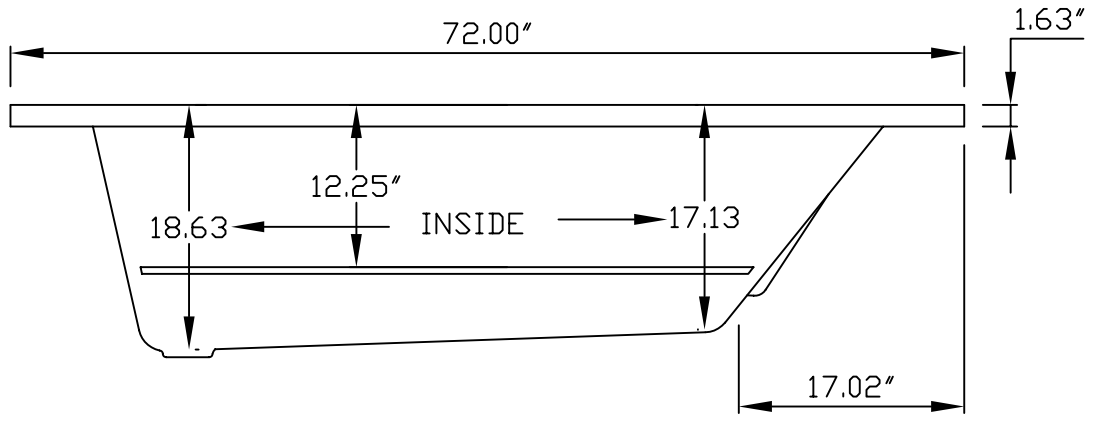
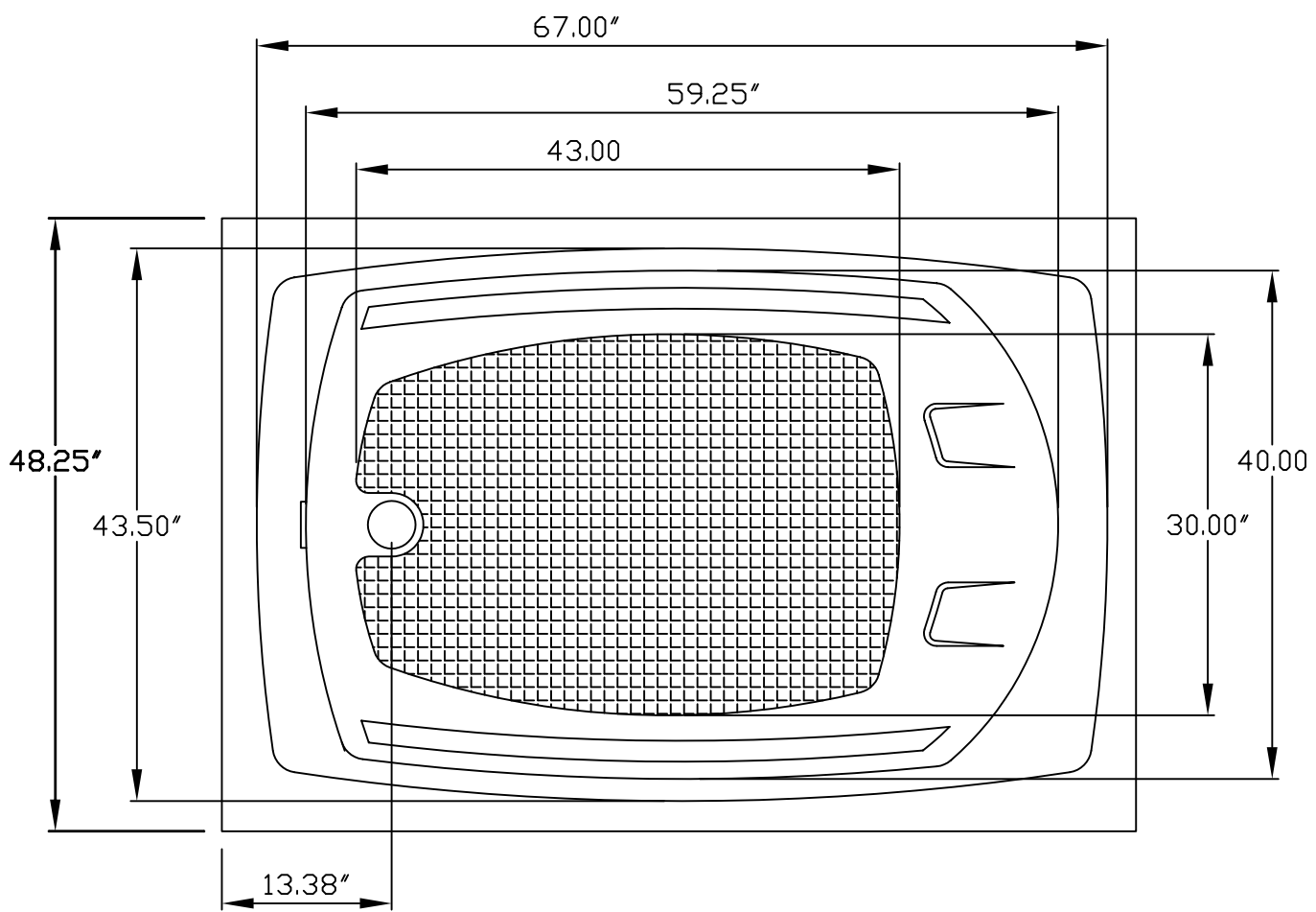

		<h1>Quality Acrylic Baths</h1>		
SIZE A	FSCM NO.	DWG NO. QAB MODEL 511	REV IR	
SCALE		SHEET 1 OF 1		